

:seating
SOLUTIONS

alea

catalogue

table of contents

02
Task

32
Managerial

56
Executive

82
Visitor

92
Hybrid

100
Community

task

Le sedute “task” o operative assicurano i massimi livelli di durevolezza ed ergonomicità. Comode, funzionali e dallo stile essenziale, queste sono pensate per tutte le figure operative che spendono la maggior parte della loro giornata alla scrivania.

Queste sedie sono progettate per garantire una corretta postura del corpo, grazie all’ausilio di supporti lombari e schienali regolabili. Alla postazione di lavoro assicurano stabilità e piena sicurezza.

“Task” chairs ensure the highest levels of durability and ergonomics. Comfortable, functional and with an essential design, they are intended for professionals who spend most of their day at the desk.

These chairs are designed to ensure correct body posture with the aid of lumbar supports and heightadjustable backrests. They provide stability and complete safety at work.

Les assises “task” ou opérationnelles garantissent les plus hauts niveaux de durabilité et d’ergonomie. Confortables, fonctionnels et au design essentiel, ils sont destinés aux professionnels qui passent la majeure partie de leur journée au bureau.

Ces chaises sont conçues pour assurer une posture correcte du corps grâce à des supports lombaires et des dossiers réglables en hauteur. Au poste de travail assure la stabilité et la sécurité totale.

Las sillas “task” o de trabajo garantizan los más altos niveles de durabilidad y ergonomía. Cómodas, funcionales y con un diseño esencial, están pensadas para los profesionales que pasan la mayor parte del día en el escritorio.

Estas sillas están diseñadas para garantizar una postura corporal correcta con la ayuda de soportes lumbares y respaldos regulables en altura. Garantizan estabilidad y total seguridad en el puesto de trabajo.

04
T10

10
T30

16
T35

20
T50

26
T70

T10



T10 è una sedia operativa caratterizzata da linee semplici e pulite, perfetta per un utilizzo intensivo e professionale.

T10 is a task chair with clean and essential lines, perfect for intensive and professional use.

T10 est une chaise opérative caractérisée par des lignes simples et propres, parfaite pour usage intensif et professionnel.

T10 es una silla de trabajo caracterizada por líneas simples y limpias, perfecta para un uso intensivo y profesional.

Il comodo schienale
in rete presenta
un supporto lombare
regolabile di
colore nero.



The comfortable mesh
backrest is fitted with an
adjustable black
lumbar support.

Le dossier en maille
confortable est équipé
d'un support lombaire
noir réglable.

El cómodo respaldo de
malla está provisto
de un soporte lumbar
negro ajustable.

Varianti | Variants | Variantes | Variantes

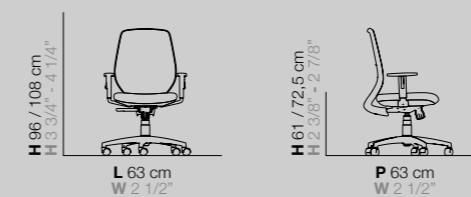

Finiture | Finishes | Finitions | Acabados

		STD			
Struttura Frame Structure Estructura	→			Rivestimento sedile Seat upholstery Revêtement de siège Revestimiento del asiento	→
Base Base Base Base	→			Rivestimento schienale Backrest upholstery Revêtement du dossier Revestimiento del respaldo	→
Supporto lombare Lumbar support Soutien lombaire Apoyo lumbar	→				

Mix & match

Varianti Variants Variantes Variantes	Schienali Backrests Dossier Respaldos	Meccanismi Mechanisms Mécanismes Mecanismos	Braccioli Adjustable Accoudoirs Reposabrazos	Colori struttura e base Frame and base colours Couleurs base et structure Colores base y estructura	Rivestimento sedile Seat upholstery Revêtement de siège Revestimiento del asiento



T30



T30 è una sedia operativa che fa della comodità ed dell'ergonomicità i suoi punti di forza. Ideale per un uso quotidiano e prolungato grazie alle numerose possibilità di declinazione disponibili.

T30 is a task chair that makes comfort and ergonomics its strengths. It is ideal for daily and extended use, thanks to the various declinations available.

T30 est une chaise opérative qui fait du confort et de l'ergonomie sa force. Elle est idéale pour une utilisation quotidienne et prolongée grâce aux plusieurs possibilités de déclinaison.

T30 es una silla de trabajo cuyos puntos fuertes son comodidad y manejo ergonómico. Ideal para el utilizo diario y prolongado, gracias a las numerosas posibilidades de uso.

Lo schienale può essere in rete o rivestito in tessuto, è regolabile in altezza e include un supporto lombare.



The backrest is available in mesh or fabric, is adjustable in height and can be fitted with a lumbar support.

Le dossier est conçu en résille ou en tissu, il est réglable en hauteur et il est équipé d'un support lombaire.

El respaldo, que puede ser en malla o tapizado, es ajustable en altura y cuenta con un apoyo lumbar.

Varianti | Variants | Variantes | Variantes

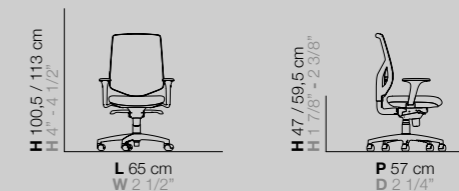
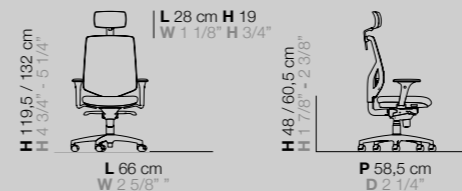

Finiture | Finishes | Finitions | Acabados

	STD			
Struttura Frame Structure Estructura	→			
Base Base Base Base	→			
Supporto lombare Lumbar support Soutien lombaire Apoyo lumbar	→			
				Rivestimento sedile Seat upholstery Revêtement de siège Revestimiento del asiento
				→
				Rivestimento schienale Backrest upholstery Revêtement du dossier Revestimiento del respaldo
				→
				Rivestimento poggiatesta Headrest upholstery Revêtement de l'appui-tête Revestimiento del reposacabezas
				→

Mix & match

Varianti Variants Variantes Variantes	Schienali Backrests Dossier Respaldos	Meccanismi Mechanisms Mécanismes Mecanismos	Braccioli Adjustable Accoudoirs Reposabrazos	Colori struttura e base Frame and base colours Couleurs base et structure Colores base y estructura	Rivestimento seduta Seat upholstery Revêtement de siège Revestimiento del asiento



T35



T35 è una sedia operativa elegante e moderna, adatta a offrire comfort e relax ai professionisti che trascorrono molte ore alla scrivania.

T35 is an elegant and modern task chair, perfect for providing comfort and relaxation to professionals who spend many hours at their desks.

T35 est une chaise de travail élégante et moderne, parfaite pour offrir confort et détente aux professionnels qui passent nombreuses heures au bureau.

T35 es una silla de trabajo elegante y moderna, adecuada para ofrecer confort y relax a los profesionales que pasan muchas horas en el escritorio.

È dotata di un supporto lombare regolabile in altezza.

It features a lumbar support adjustable in height.

Le support lombaire est intégré et réglable en hauteur.

El apoyo lumbar está integrado y es ajustable en altura.



Varianti | Variants | Variantes | Variantes

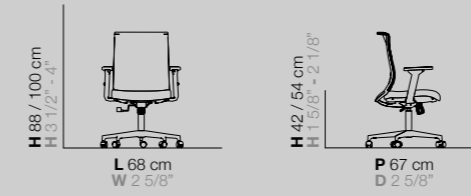

Finiture | Finishes | Finitions | Acabados

		STD			
Struttura Frame Structure Estructura	→			Rivestimento sedile Seat upholstery Revêtement de siège Revestimiento del asiento	→
Base Base Base Base	→			Rivestimento schienale Backrest upholstery Revêtement du dossier Revestimiento del respaldo	→
Supporto lombare Lumbar support Soutien lombaire Apoyo lumbar	→				

Mix & match

Varianti Variants Variantes Variantes	Schienali Backrests Dossier Respaldos	Meccanismi Mechanisms Mécanismes Mecanismos	Braccioli Adjustable Accoudoirs Reposabrazos	Colori struttura e base Frame and base colours Couleurs base et structure Colores base y estructura	Rivestimento seduta Seat upholstery Revêtement de siège Revestimiento del asiento

T35

T50



T50

T50 è una seduta che si distingue per linee arrotondate e morbide, perfetta per ambienti dal carattere dinamico ed innovativo.

T50 is a chair distinguished by its smooth and soft lines, well suited to environments with a dynamic and innovative character.

T50 est une chaise qui se distingue par des lignes arrondies et douces, parfaite pour les environnements avec un caractère dynamique et innovant.

T50 es una silla que destaca por líneas redondeadas y suaves, perfecta para ambientes de carácter dinámico e innovador.



La sedia presenta un supporto lombare regolabile in altezza caratterizzato da un'originale forma ovale.

The chair features a height-adjustable lumbar support characterised by an original oval shape.

Le T50 est doté d'un support lombaire réglable en hauteur et il se caractérise par une forme ovale originale.

T50 ofrece un apoyo lumbar ajustable en altura caracterizado por una original forma oval.





Varianti | Variants | Variantes | Variantes

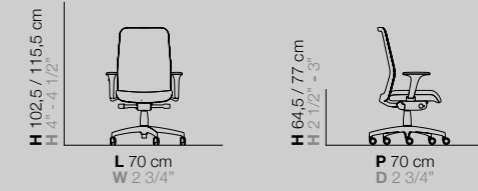
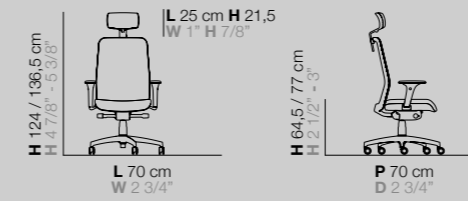

T50

Finiture | Finishes | Finitions | Acabados

		STD		
Struttura Frame Structure Estructura	→			Rivestimento sedile Seat upholstery Revêtement de siège Revestimiento del asiento
				→
Base Base Base Base	→			Rivestimento schienale Backrest upholstery Revêtement du dossier Revestimiento del respaldo
				→
Supporto lombare Lumbar support Soutien lombaire Apoyo lumbar	→			Rivestimento poggiatesta Headrest upholstery Revêtement de l'appui-tête Revestimiento del reposacabezas
				→

Mix & match

Varianti Variants Variantes Variantes	Schienali Backrests Dossier Respaldos	Meccanismi Mechanisms Mécanismes Mecanismos	Braccioli Adjustable Accoudoirs Reposabrazos	Colori struttura e base Frame and base colours Couleurs base et structure Colores base y estructura	Rivestimento seduta Seat upholstery Revêtement de siège Revestimiento del asiento

T70



T70 è una sedia full-mesh che si distingue dalle altre sedute operative per il suo design moderno e ricercato.

T70 is a full-mesh task chair that stands out from the others for its modern and sophisticated design.

T70 est une chaise entièrement en résille qui se distingue des autres chaises opératives pour son design moderne et recherché.

T70 es una silla totalmente en malla, que destaca para su diseño moderno y sofisticado.

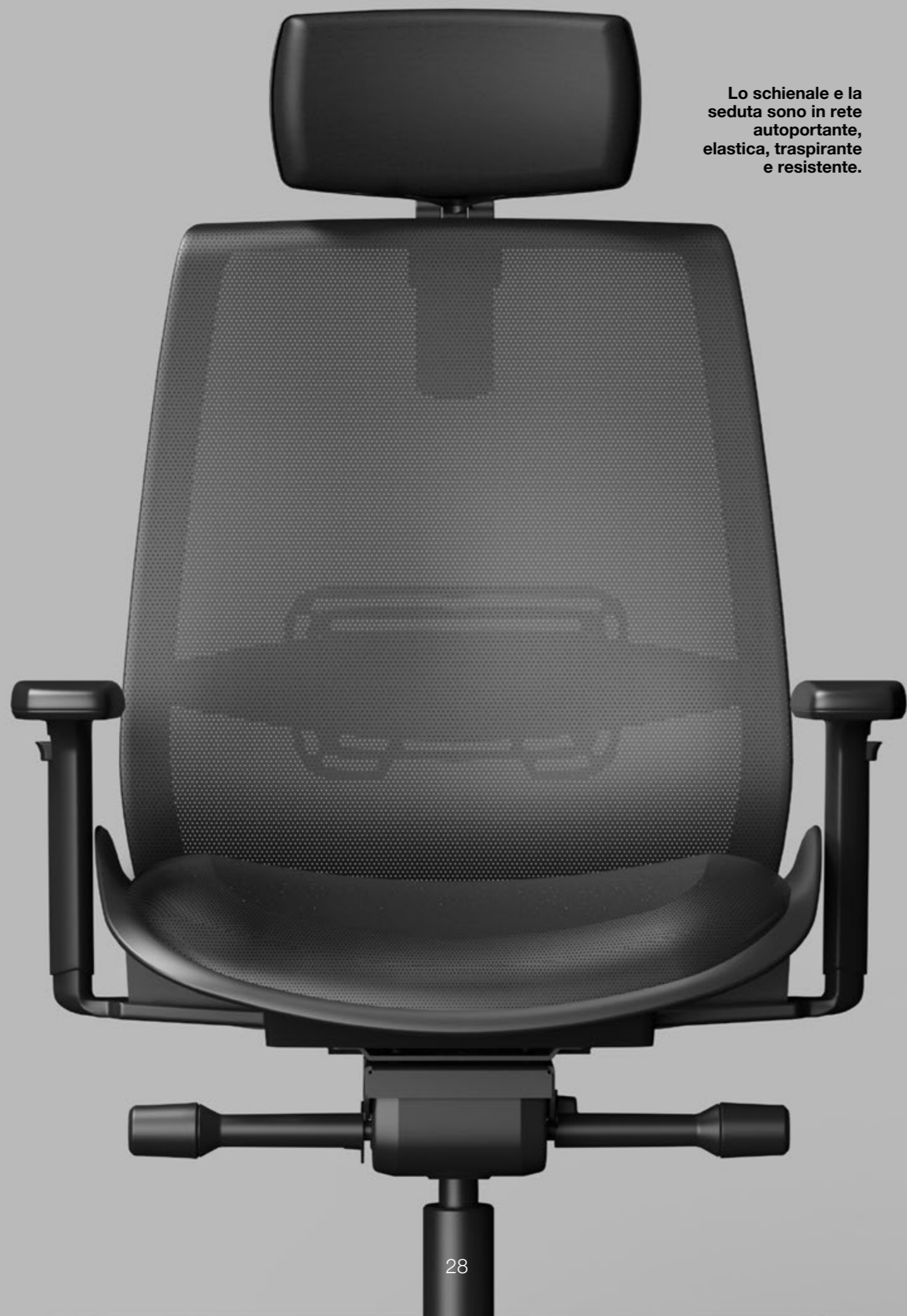

Lo schienale e la
seduta sono in rete
autoportante,
elastica, traspirante
e resistente.



The backrest and seat
are in self-supporting,
breathable and resistant
technical mesh.

Le dossier et l'assise sont
en résille autoportante,
élastique, transpirante
et résistante.

Respaldo y asiento
son en malla autoportante,
elástica, transpirable
y duradera.



Varianti | Variants | Variantes | Variantes

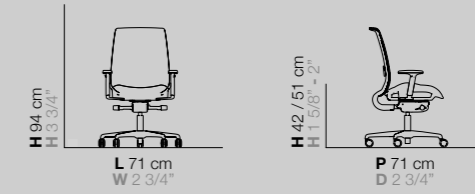
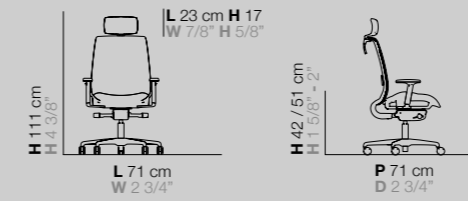

T70

Finiture | Finishes | Finitions | Acabados

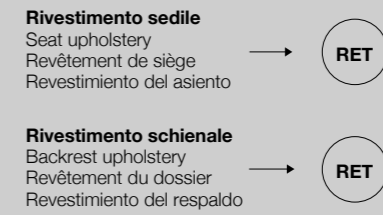
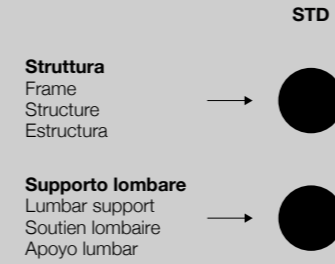

Poggiatesta in PU rivestito in similpelle nera
 PU headrest upholstered in black faux leather
 Appui-tête en PU recouvert de faux-cuir noir
 Reposacabeza en PU tapizado en eco piel negra

Mix & match



managerial

Le sedute “managerial” o manageriali sono una linea con una duplice importante valenza: garantire un alto livello di rappresentatività, particolarmente in contesti di incontro con persone esterne all’azienda, e assicurare il comfort per un utilizzo prolungato durante la giornata.

Questa linea è pensata per le figure direzionali. Le forme impiegate sono contemporanee ed ergonomiche, mettendo la funzionalità al primo posto senza rinunciare alla qualità e all’attenzione per i dettagli.

“Managerial” chairs are a line with a dual value. They ensure a high level of representativeness (particularly for meetings with people from outside the company) and, at the same time, provide comfort for extended use throughout the day.

This category of seats is intended for management profiles. The lines are comfortable and ergonomic, prioritising functionality without compromising on quality of detail.

Les “managerial” ou de gestion sont une ligne de assises avec un double valeur: garantir un haut niveau de représentativité, en particulier pour réunion avec clients, en même temps, confort pour une utilisation prolongée au cours de la journée.

Cette ligne est conçue pour figures directionnelles. Les lignes sont confortables et ergonomiques, privilégiant la fonctionnalité sans compromettre la qualité des détails.

Las sillas “managerial” o gerenciales son una línea con un doble valor importante: garantizan un alto nivel de representatividad, sobre todo en contextos de reunión con personas ajenas a la empresa, y al mismo tiempo comodidad para un uso prolongado a lo largo del día.

Esta línea está pensada para las figuras directivas. Las líneas son cómodas y ergonómicas, y dan prioridad a la funcionalidad sin renunciar a la calidad de los detalles.

34
M10

42
M30

48
M50

M10



M10 è una sedia manageriale dai tratti leggeri ed eleganti, una perfetta fusione tra stile e comfort.



M10 is a managerial chair with light and elegant features that perfectly combines style and comfort.

M10 est une chaise mangériale avec traits légers et élégants, une parfaite fusion de style et de confort.

M10 es una silla gerencial con características ligeras y elegantes, una fusión perfecta de estilo y comodidad.

Nel sinuoso schienale,
in rete o rivestito in
tessuto, è integrato
un ergonomico
supporto lombare
regolabile in altezza.



The sinuous backrest is
available in mesh or fabric
and features an ergonomic,
height-adjustable
lumbar support.

Le sinueux dossier en
résille ou en tissu est
équipé d'un support
lombaire ergonomique
réglable en hauteur.

En el sinuoso respaldo,
en malla o tapizado,
se incorpora un apoyo
lumbar ergonómico,
ajustable en altura.







Varianti | Variants | Variantes | Variantes

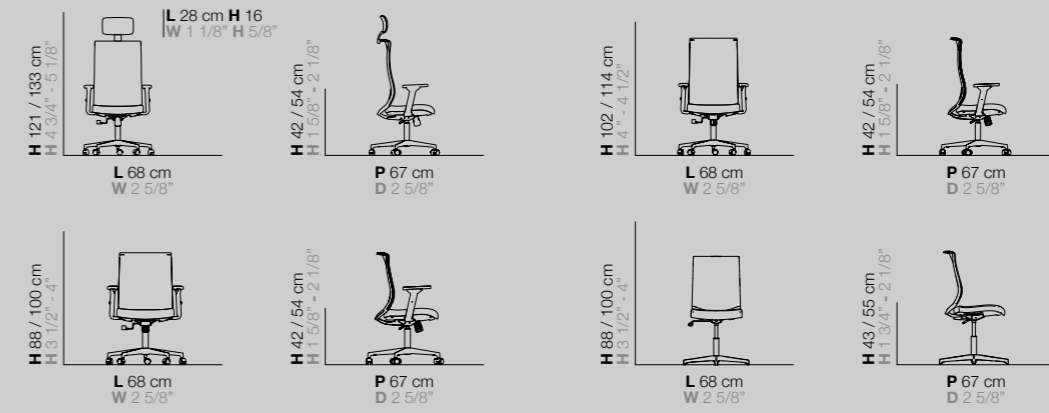

M10

Finiture | Finishes | Finitions | Acabados

	STD	STD			
Struttura Frame Structure Estructura	→	/		Rivestimento sedile Seat upholstery Revêtement de siège Revestimiento del asiento	→
Base Base Base Base	→			Rivestimento schienale Backrest upholstery Revêtement du dossier Revestimiento del respaldo	→
Supporto lombare Lumbar support Soutien lombaire Apoyo lumbar	→	/		Rivestimento poggiatesta Headrest upholstery Revêtement de l'appui-tête Revestimiento del reposacabezas	→

Mix & match

Varianti Variants Variantes Variantes	Schienali Backrests Dossier Respaldos	Meccanismi Mechanisms Mécanismes Mecanismos	Braccioli Adjustable Accoudoirs Reposabrazos	Colori struttura Frame colours Couleurs structure Colores estructura	Colori base Base colours Couleurs base Colores base	Rivestimento seduta Seat upholstery Revêtement de siège Revestimiento del asiento

M30



M30 è un'elegante sedia manageriale caratterizzata da forme ergonomiche e morbide, perfetta per un utilizzo prolungato.

M30 is an elegant executive chair with soft, ergonomic lines, perfect for prolonged use.

M30 est une chaise managériale élégante caractérisée par des formes ergonomiques et douces, parfaite pour une utilisation prolongée.

M30 es una silla gerencial que destaca por sus formas ergonómicas y suaves, idónea para su utilizzo prolongado.



**Il comodo schienale
in PU schiumato è
regolabile in altezza
e può essere
rivestito in tessuto,
pelle o similpelle.**

M30



The comfortable PU foam backrest is height-adjustable and can be upholstered in fabric, leather or faux leather.

Le dossier confortable en mousse PU, est réglable en hauteur et il peut être revêtu en tissu, cuir ou faux-cuir.

El cómodo respaldo en espuma de PU es regulable en altura y puede tapizarse en tela, cuero o eco-piel.





Varianti | Variants | Variantes | Variantes

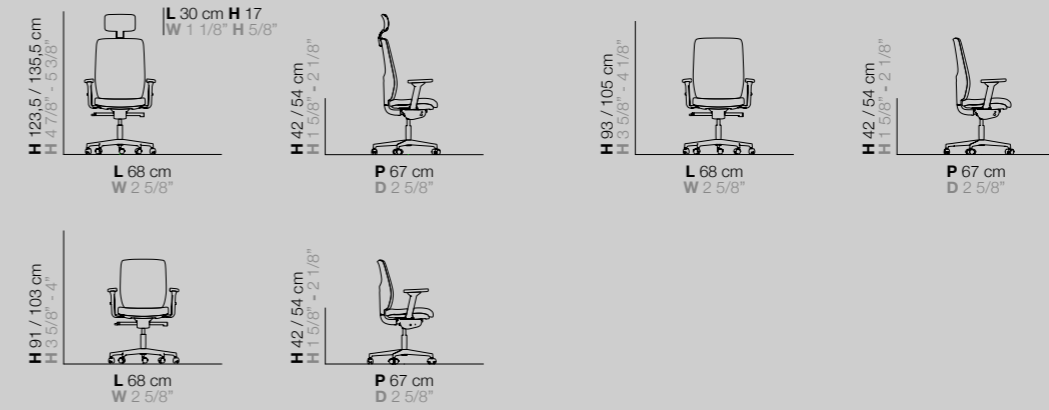

M30

Finiture | Finishes | Finitions | Acabados

	<p>STD STD </p>	
<p>Struttura Frame Structure Estructura</p>	<p>→ ● / ●</p>	<p>Rivestimento sedile Seat upholstery Revêtement de siège Revestimiento del asiento</p> <p>→ ● (TES) ● (PEL)</p>
<p>Base Base Base Base</p>	<p>→ ● ● ●</p>	<p>Rivestimento schienale Backrest upholstery Revêtement du dossier Revestimiento del respaldo</p> <p>→ ● (TES) ● (PEL)</p>
		<p>Rivestimento poggiatesta Headrest upholstery Revêtement de l'appui-tête Revestimiento del reposacabezas</p> <p>→ ● (TES) ● (PEL)</p>

Mix & match

3	2	2	2	2	3	106
<p>Varianti Variants Variantes Variantes</p>	<p>Schienali Backrests Dossier Respaldos</p>	<p>Meccanismi Mechanisms Mécanismes Mecanismos</p>	<p>Braccioli Adjustable Accoudoirs Reposabrazos</p>	<p>Colori struttura Frame colours Couleurs structure Colores estructura</p>	<p>Colori base Base colours Couleurs base Colores base</p>	<p>Rivestimento seduta Seat upholstery Revêtement de siège Revestimiento del asiento</p>

M50



M50 è una sedia manageriale dal carattere deciso e dalle linee autorevoli, perfetta per ambienti eleganti e sofisticati.



M50 is a managerial chair with a strong character and authoritative lines, perfect for elegant and sophisticated environments.

M50 est une chaise mangériale avec un caractère décidé et des lignes d'autorité, parfaite pour les environnements élégants et sophistiqués.

M50 es una silla gerencial con carácter fuerte y líneas decididas, ideal para ambientes elegantes y sofisticados.



**Le linee raffinate e i
dettagli tecnici
rendono la poltrona
ergonomica, comoda
e dallo stile ricercato.**

M50



Its refined lines and
technical details make it an
ergonomic, comfortable,
and sophisticated armchair.

Les lignes raffinées et les
détails techniques rendent
cette chaise ergonomique,
confortable et avec une
style recherché.

Las líneas refinadas y
los detalles técnicos, la
convierten en un sillón
ergonómico, cómodo y con
un estilo sofisticado.





Varianti | Variants | Variantes | Variantes

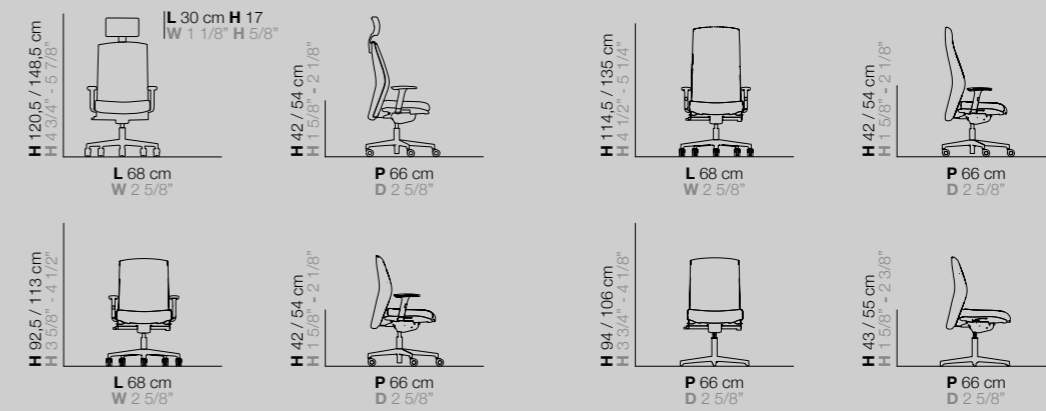

M50

Finiture | Finishes | Finitions | Acabados

	STD	STD		
Struttura Frame Structure Estructura	→ ●	/	Rivestimento sedile Seat upholstery Revêtement de siège Revestimiento del asiento	→ ● TES ● PEL
Base Base Base Base	→ ●	●	Rivestimento schienale Backrest upholstery Revêtement du dossier Revestimiento del respaldo	→ ● TES ● PEL
			Rivestimento poggiatesta Headrest upholstery Revêtement de l'appui-tête Revestimiento del reposacabezas	→ ● TES ● PEL

Mix & match

4	2	3	3	1	2	106
Varianti Variants Variantes Variantes	Schienali Backrests Dossier Respaldos	Meccanismi Mechanisms Mécanismes Mecanismos	Braccioli Adjustable Accoudoirs Reposabrazos	Colori struttura Frame colours Couleurs structure Colores estructura	Colori base Base colours Couleurs base Colores base	Rivestimento seduta Seat upholstery Revêtement de siège Revestimiento del asiento

executive

Le sedute “executive” o direzionali esprimono in modo chiaro e immediato lo stile rappresentativo e unico di un’azienda e del suo management.

Attraverso un’attenta ricerca progettuale, la qualità dei materiali utilizzati (es. pelle ed simil-pelle) e la cura di ogni minimo dettaglio, coniugano prestigio e autorevolezza, design ed efficienza, funzionalità ed ergonomia.

“Executive” chairs clearly and immediately express the representative and unique style of a company and its management.

Thanks to careful design research, quality of the materials used (e.g. leather and faux leather) and attention to even the smallest detail, they combine prestige and authority, design and efficiency, functionality and ergonomics.

Les chaises “executive” ou de direction expriment avec instantanéité et clarté la représentativité et un style distinctif d’une entreprise et ses dirigeants.

Grâce à une recherche attentive relative aux projets, la qualité des matériaux utilisés (par ex. cuir et faux-cuir) et le soin de chaque détail, allient prestige et autorité, design et efficacité, fonctionnalité et ergonomie.

Los asientos “executive” o ejecutivos expresan con inmediatez y claridad la representatividad y el estilo distintivo de una empresa y, en particular, de sus dirigentes.

La cuidadosa investigación de diseño, la calidad de los materiales utilizados, como cuero y ecopiel, y la atención a cada detalle combinan prestigio y autoridad, estética y eficiencia, funcionalidad y ergonomía.

58
E10

66
E30

74
E50

E10



E10 è una collezione di poltrone direzionali caratterizzate da linee pulite e sofisticate, perfette per uffici moderni e classici.

E10 is a collection of executive chairs characterised by clean and sophisticated lines, perfect for both modern and classic offices.

E10 est une collection de chaises qui est caractérisée par des lignes claires et sophistiquées, qui la rend polyvalente pour bureaux modernes que classiques.

E10 es una colección de asientos que se caracteriza por líneas limpias y sofisticadas, que la hacen versátil tanto para oficinas modernas como clásicas.



E10

Lo schienale può essere in rete autoportante, tessuto o in pelle. La struttura può essere cromata o verniciata su richiesta.

The backrest is available in mesh or upholstered fabric, leather or faux leather. The frame can be chrome-plated or powder-coated in a matching colour.

Le dossier est disponible en résille autoportante, ou en tissu ou en cuir. La structure peut être chromée ou vernie sur demande.

El respaldo está fabricado en malla autoportante, tela o cuero. La estructura puede cromarse o pintarse bajo pedido.





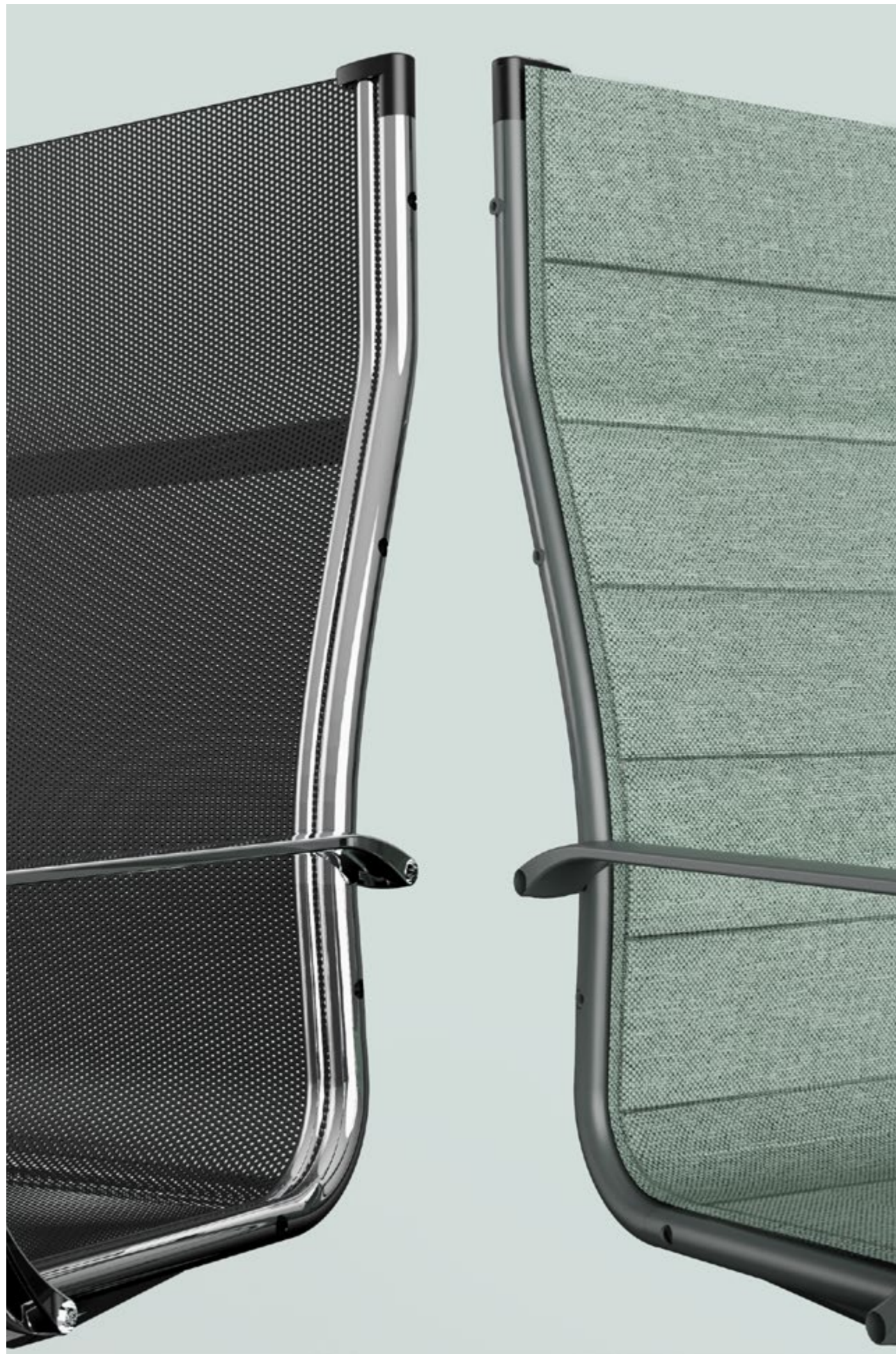

Varianti | Variants | Variantes | Variantes

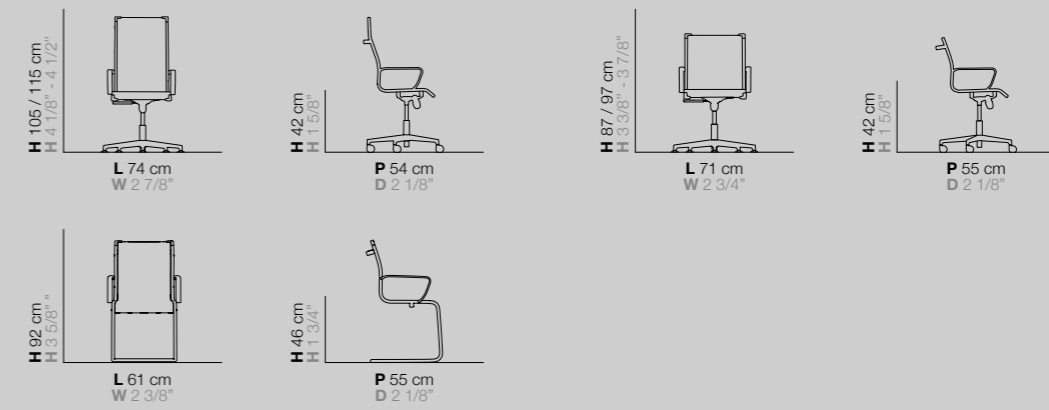

Finiture | Finishes | Finitions | Acabados

	STD	STD		
Struttura Frame Structure Estructura	→	→	→	
Base Base Base Base	→	→	→	
				Rivestimento seduta Seat upholstery Revêtement de siège Revestimiento del asiento
				→

Mix & match

Varianti Variants Variantes Variantes	Meccanismi Mechanisms Mécanismes Mecanismos	Braccioli Adjustable Accoudoirs Reposabrazos	Colori struttura e base Frame and base colours Couleurs base et structure Colores base y estructura	Rivestimento seduta Seat upholstery Revêtement de siège Revestimiento del asiento

E30

E30 si caratterizza per le linee morbide ed avvolgenti, per un design classico che dona importanza all'ambiente ufficio.



E30 is characterised by soft, enveloping lines and a classic design that enhances the office environment.

E30 se caractérise par des lignes douces et enveloppantes, pour un design classique qui donne importance à l'environnement du bureau.

E30 se caracteriza por sus líneas suaves y envolventes, para un diseño clásico que confiere importancia al entorno de oficina.

Può essere rivestita
sia in tessuto che
in pelle in base alle
esigenze del cliente.



Depending on the
customer's requirements,
it can be upholstered
in fabric, leather
or faux leather.

Elle peut être revêtue en
tissu mais aussi en
cuir selon les
exigences du client.

Puede tapizarse en
tela o cuero, según
las necesidades del cliente.





Varianti | Variants | Variantes | Variantes

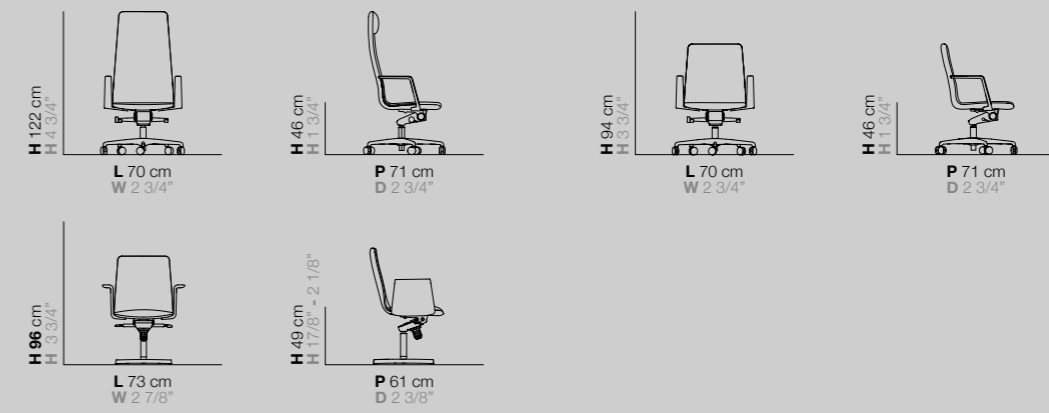

E30

Finiture | Finishes | Finitions | Acabados

STD

Struttura
Frame
Structure
Estructura →

Base
Base
Base
Base →

Rivestimento seduta
Seat upholstery
Revêtement de siège
Revestimiento del asiento →

Mix & match

Varianti Variants Variantes Variantes	Schienali Backrests Dossier Respaldos	Meccanismi Mechanisms Mécanismes Mecanismos	Braccioli Adjustable Accoudoirs Reposabrazos	Colori struttura Frame colours Couleurs structure Colores estructura	Colori base Base colours Couleurs base Colores base	Rivestimento seduta Seat upholstery Revêtement siège Revestimiento del asiento

E50



E50

E50 è una seduta dal carattere deciso e importante. Un design forte che connota l'ambiente di lavoro.



E50 is a chair with a strong character and a distinctive design, which plays a leading role in the environment in which it is placed.

E50 est une chaise avec un caractère décisif et important. Un design fort qui donne une importance à l'environnement de travail.

E50 es un asiento con un carácter decidido e importante. Se presenta con un diseño fuerte, que caracteriza el entorno de trabajo.

La forma particolare della seduta rende questa poltrona direzionale un must di accoglienza.

The unusual shape of the seat makes this executive chair an inviting must-have.

La forme particulière de la chaise rend ce fauteuil de direction un must de l'accueil.

La forma particular del asiento hace que este sillón gerencial sea imprescindible en cada recepción.







Varianti | Variants | Variantes | Variantes

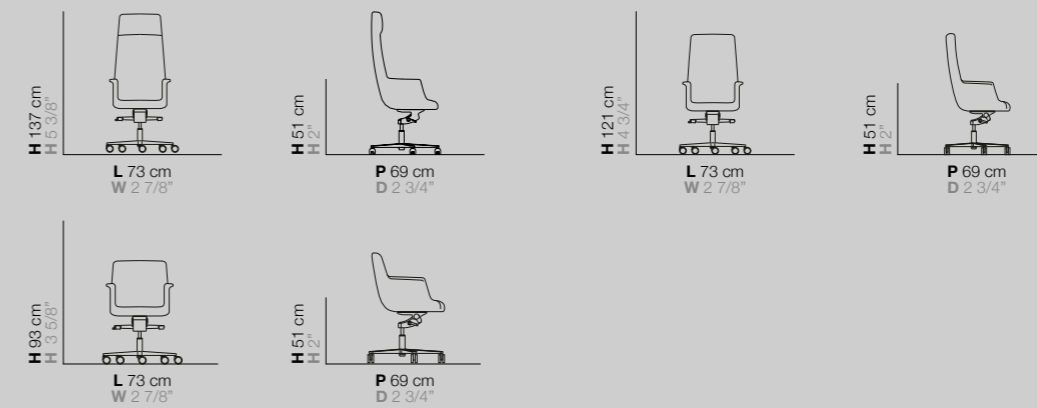

E50

Finiture | Finishes | Finitions | Acabados

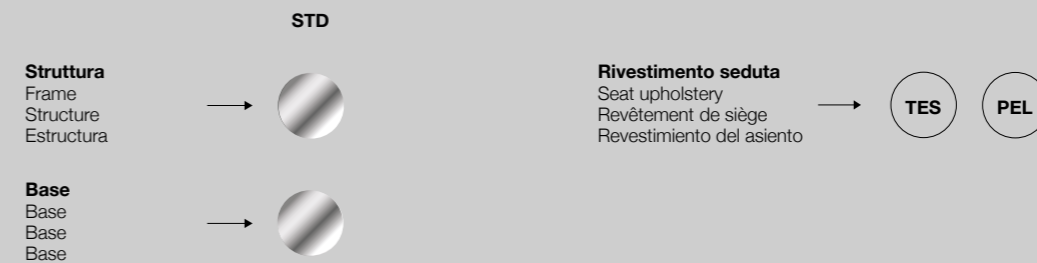

Mix & match



visitor

Le sedute “visitor” o visitatore sono ideali per un utilizzo non prolungato, progetti contract, allestimento di sale d’attesa di studi professionali oppure per sale riunioni, conferenze aziendali o d’ufficio, oltre che per funzioni di servizio in ambiti domestici.

Si tratta di sedie che si caratterizzano per la massima versatilità, pensate per garantire il miglior equilibrio possibile fra necessità di comfort, praticità e distintiva eleganza.

“Visitor” chairs are designed for short-term use, ideal for contract projects, for furnishing waiting rooms in professional and medical environments, for business or office meetings and conferences, and for service functions in domestic environments.

These chairs are characterised by maximum versatility in order to guarantee the best possible balance between the need for comfort and prestige. They are of remarkable practicality and at the same time of unmistakable elegance.

Les assises “visitor” ou visiteurs sont parfaites pour une utilisation pas prolongée, idéales pour projets contract, la mise en place pour les salles d’attente de bureaux professionnels, réunions, conférences, ainsi que pour fonctions de service domestique.

Il s’agit de chaises très polyvalentes, pensées pour assurer le meilleur équilibre entre nécessité de confort, grande praticité et d’une élégance distinctive.

Las sillas “visitor” o de visita son adecuadas para un uso no prolongado, ideales para proyectos contract, la decoración de salas de espera en despachos profesionales y médicos, reuniones y conferencias en empresas u oficinas, así como para funciones de servicio en entornos domésticos.

Estas sillas se caracterizan por su máxima versatilidad, diseñadas para garantizar el mejor equilibrio posible entre comodidad, practicidad y una elegancia distintiva.

84
V20

V20



V20 è una seduta versatile, che si adatta a diverse tipologie di ambiente. Presenta linee eleganti e semplici che le danno un tocco moderno.

V20 is a versatile chair that adapts to different types of environments. It has elegant and simple lines that give it a modern touch.

V20 est une chaise polyvalente, qui s'adapte aux différents types d'environnement. Elle est équipée de lignes élégantes et simples que lui donnent une touche moderne.

V20 es un asiento inteligente, que se adapta a diferentes tipos de entorno. Presenta unas líneas elegantes y sencillas que le confieren un toque moderno.



La struttura è disponibile nelle varianti bianco e nero e la seduta può essere rivestita con la vasta gamma di tessuti disponibili.



The frame is available in white or black and the seat can be upholstered in a wide range of fabrics.

La structure est disponible en blanc et en noir et l'assise peut être revêtue en toutes finitions disponibles.

La estructura está disponible en blanco y negro, colores acompañados por una amplia gama de tejidos ecosostenibles.





Varianti | Variants | Variantes | Variantes

V20

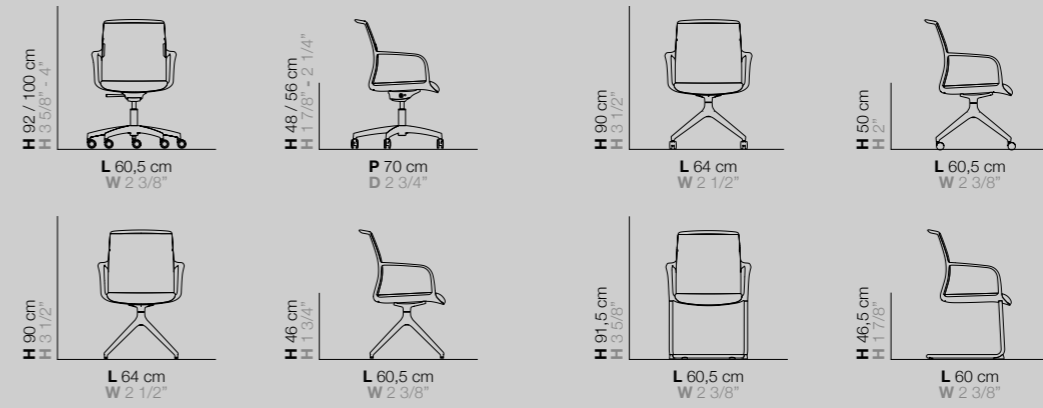

Finiture | Finishes | Finitions | Acabados

Struttura
Frame
Structure
Estructura

→ **STD**

→

Base
Base
Base
Base

→

Rivestimento sedile
Seat upholstery
Revêtement de siège
Revestimiento del asiento

→

Rivestimento schienale
Backrest upholstery
Revêtement du dossier
Revestimiento del respaldo

→

Mix & match

Varianti Variants Variantes Variantes	Schienali Backrests Dossier Respaldos	Meccanismi Mechanisms Mécanismes Mecanismos	Colori struttura Frame colours Couleurs structure Colores estructura	Colori base Base colours Couleurs base Colores base	Rivestimento seduta Seat upholstery Revêtement de siège Revestimiento del asiento

hybrid

La categoria “hybrid” o ibrida vuole soddisfare particolari esigenze che non trovano piena risposta dalle altre linee più specifiche.

Le sedute sono versatili e si adattano facilmente a diverse tipologie di ambienti.

Sono prodotti dalle linee più semplici, che non presentano particolari rivestimenti e finiture. Conseguentemente, sono ideali ad accompagnare tavoli hot-desking o riunione.

The ‘Hybrid’ category is designed to meet specific needs that are not fully met by other, more specific lines.

The chairs are versatile and easily adaptable to different types of environments.

These chairs have clean and essential lines and do not have special upholstery and finishes. This makes them ideal for hot-desking or meeting tables.

La catégorie “hybride” ou hybride est destinée à répondre à des besoins particuliers qui ne sont pas entièrement satisfaits par les autres lignes plus spécifiques.

Les chaises sont polyvalentes et s’adaptent facilement à différents types d’environnements.

Il s’agit de produits aux lignes plus simples, sans rembourrage ni finitions particulières. Par conséquent, elles sont idéales pour accompagner les tables de hot-desking ou de réunion.

La categoría “híbrida” o híbrida está pensada para satisfacer necesidades particulares que no quedan totalmente cubiertas por las otras líneas más específicas. Son asientos versátiles que se adaptan fácilmente a distintos tipos de entornos.

Son productos de líneas más sencillas que no presentan tapizados ni acabados especiales.

En consecuencia, son ideales para acompañar mesas de hot-desking o de reuniones.

94
H10

H10



H10 è una collezione di sedute ibride dal design tecnico ed essenziale. La sua versatilità la rende perfettamente collocabile in diversi ambiti e contesti.

H10 is a collection of hybrid chairs with an essential and technical design. Its versatility makes it perfectly adaptable to different spaces and contexts.

H10 est une collection de chaises hybrides avec un design technique et essentiel. Elle trouve une parfaite collocation dans nombreux domaines et espaces.

H10 es una colección de asientos híbridos con un diseño técnico y esencial. Su versatilidad la hace perfectamente ubicable en múltiples ámbitos y espacios.



La seduta è interamente in rete e nel basamento dello sgabello è presente un poggiapiedi ad anello in acciaio.



The seat is made entirely of mesh and the stool base is fitted with an aluminium ring footrest.

La chaise est entièrement en résille et la structure du tabouret est équipée d'un repose-pieds en anneau d'acier.

El asiento es totalmente de malla y en la base del taburete hay un reposapiés de aro de acero.



Varianti | Variants | Variantes | Variantes

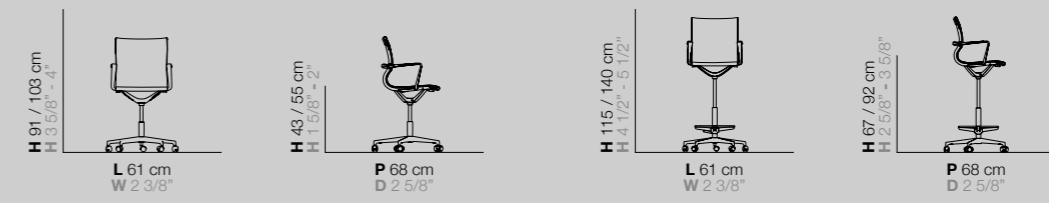

H10

Finiture | Finishes | Finitions | Acabados

	STD	STD	
Struttura Frame Structure Estructura	→ ●	/	
Base Base Base Base	→ ●	●	
			Rivestimento seduta Seat upholstery Revêtement de siège Revestimiento del asiento
			→ ○ TES ○ PEL

Mix & match

○ 2	○ 2	○ 1	○ 2
Varianti Variants Variantes Variantes	Meccanismi Mechanisms Mécanismes Mecanismos	Colori struttura Frame colours Couleurs structure Colores estructura	Colori base Base colours Couleurs base Colores base

community

Le sedute “community” o per la collettività soddisfano le esigenze di platee numerose o luoghi con cambio frequente di fruitori (locali pubblici, sia al chiuso che all’aperto).

Sono estremamente leggere e maneggevoli, per favorirne gli spostamenti durante gli allestimenti. La loro impilabilità conferisce un valore aggiunto, che ne facilita lo stoccaggio.

“Community” chairs are great for accommodating large groups of people and for places with a high turnover rate. They can be found indoors and outdoors and are ideal for public spaces.

They are incredibly lightweight and manoeuvrable, making them easy to move around when setting up. Their stackability adds value by making them easier to store.

Les assises “Community” ou pour la communauté sont idéales pour accueillir de grands groupes de personnes ou pour les lieux où le taux de rotation est élevé. On les trouve à l’intérieur et à l’extérieur et elles sont idéales pour les espaces publics.

Elles sont incroyablement légères et maniables, ce qui permet de les déplacer facilement lors de l’installation. Leur empilabilité confère une valeur ajoutée en facilitant leur stockage.

Las sillas “Community” o para colectividades son ideales para acomodar a grandes grupos de personas y para lugares con un alto índice de rotación. Se pueden encontrar en interiores y exteriores y son ideales para espacios públicos.

Son increíblemente ligeras y maniobrables, lo que facilita su desplazamiento durante el montaje. Además, son apilables, lo que facilita su almacenamiento.

102
C10

108
C20

C10



C10 è una sedia dalle linee minimal ed essenziali, perfetta per gli ambienti outdoor.

C10 is a community chair with minimal and essential lines, perfect for outdoor environments.

C10 est une chaise communautaire aux lignes minimales et essentielles, parfaite pour les environnements extérieurs.

C10 es una silla comunitaria de líneas minimalistas y esenciales, perfecta para entornos exteriores.

La sua struttura a monoblocco in polipropilene garantisce notevole durabilità nel tempo e resistenza agli agenti atmosferici.

C10



Its one-piece polypropylene frame guarantees remarkable durability and weather resistance.

Sa structure en monobloc de polypropylène garantit une considérable durabilité dans le temps et résistance aux agents atmosphériques.

Su estructura en monobloque de polipropileno garantiza una notable durabilidad en el tiempo y resistencia a los agentes atmosféricos.



Tra le declinazioni possibili per C10 troviamo @Rinasco, la versione totalmente riciclata.

Possible declinations for C10 include @Rinasco, the fully recycled version.

Parmi les déclinaisons possibles pour C10 on trouve @Rinasco, la version totalement recyclée.

Entre las posibles declinaciones para C10 encontramos @Rinasco, la versión totalmente reciclada.



Impilabilità
Stackability
Empilabilité
Apilabilidad

POL
MAX 5 PZ
PCS PCS PIEZAS



Impilabilità
Stackability
Empilabilité
Apilabilidad

POL
MAX 5 PZ
PCS PCS PIEZAS



2024
COMING
SOON

2024
COMING
SOON

Varianti | Variants | Variantes | Variantes

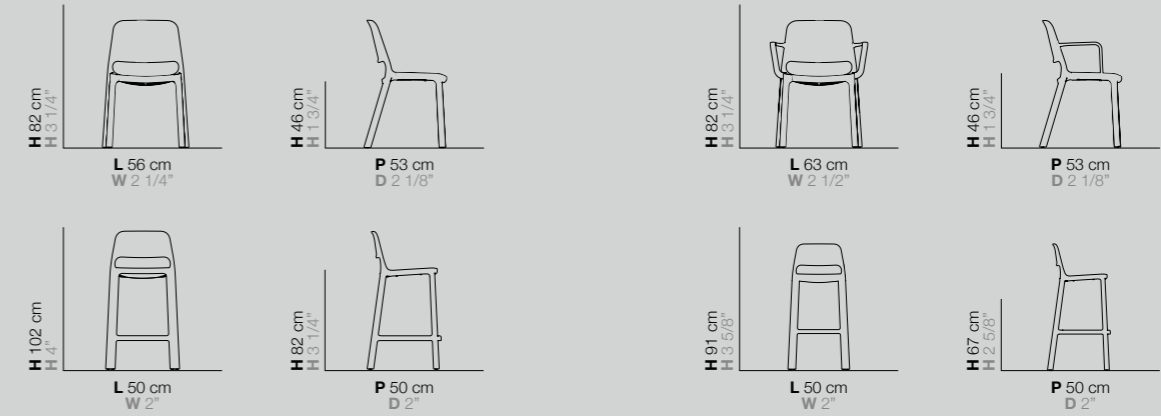

C10

Finiture | Finishes | Finitions | Acabados

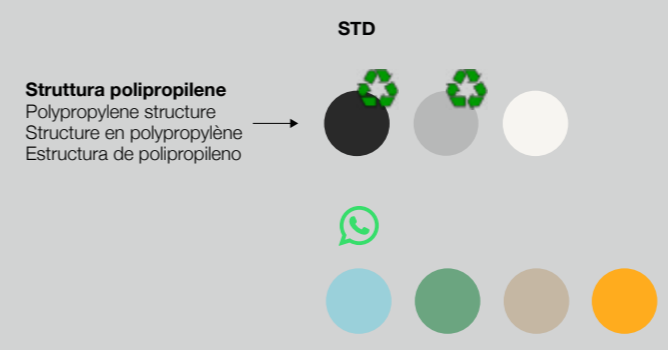

100% riciclato - Rinasco®
100% recycled - Rinasco®
100% recyclé - Rinasco®
100% reciclado - Rinasco®

Mix & match

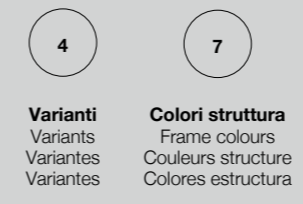

C20

C20 è la soluzione perfetta per ogni tipo di platea. La collezione si declina in otto differenti tipologie di sedute per rispondere a tutte le esigenze del cliente.



C20 is the perfect solution for every type of audience. The collection is available in eight different types of seating to meet all customer requirements.

C20 est une solution parfaite pour tout type de public. La collection se décline en huit différents types de chaises pour répondre à tous besoins des clients.

C20 es la solución perfecta para todo tipo de público. La colección está disponible en ocho tipos de asientos para satisfacer todas las necesidades de los clientes.

La scocca è
disponibile anche
nella versione
con rivestimento
anteriore, che ne
esalta la versatilità di
utilizzo ed il comfort.



The chair is also available
with front upholstery
for added versatility
and comfort.

La coque est également
disponible dans une version
recouverte sur le devant, ce
qui améliore sa polyvalence
d'utilisation et son confort.

La carcasa también está
disponible en una versión
cubierta por delante, lo que
aumenta su versatilidad de
uso y comodidad.





Impilabilità
Stackability
Empilabilité
Apilabilidad

POL
MAX 15 PZ
PCS PCS PIEZAS



Impilabilità
Stackability
Empilabilité
Apilabilidad

POL
MAX 20 PZ
PCS PCS PIEZAS

TES
MAX 15 PZ
PCS PCS PIEZAS



Impilabilità
Stackability
Empilabilité
Apilabilidad

TES
MAX 10 PZ
PCS PCS PIEZAS



Impilabilità
Stackability
Empilabilité
Apilabilidad

POL
MAX 15 PZ
PCS PCS PIEZAS

TES
MAX 10 PZ
PCS PCS PIEZAS



Impilabilità
Stackability
Empilabilité
Apilabilidad

POL
MAX 20 PZ
PCS PCS PIEZAS

TES
MAX 15 PZ
PCS PCS PIEZAS



Impilabilità
Stackability
Empilabilité
Apilabilidad

POL
MAX 15 PZ
PCS PCS PIEZAS

TES
MAX 10 PZ
PCS PCS PIEZAS





C20

Varianti | Variants | Variantes | Variantes

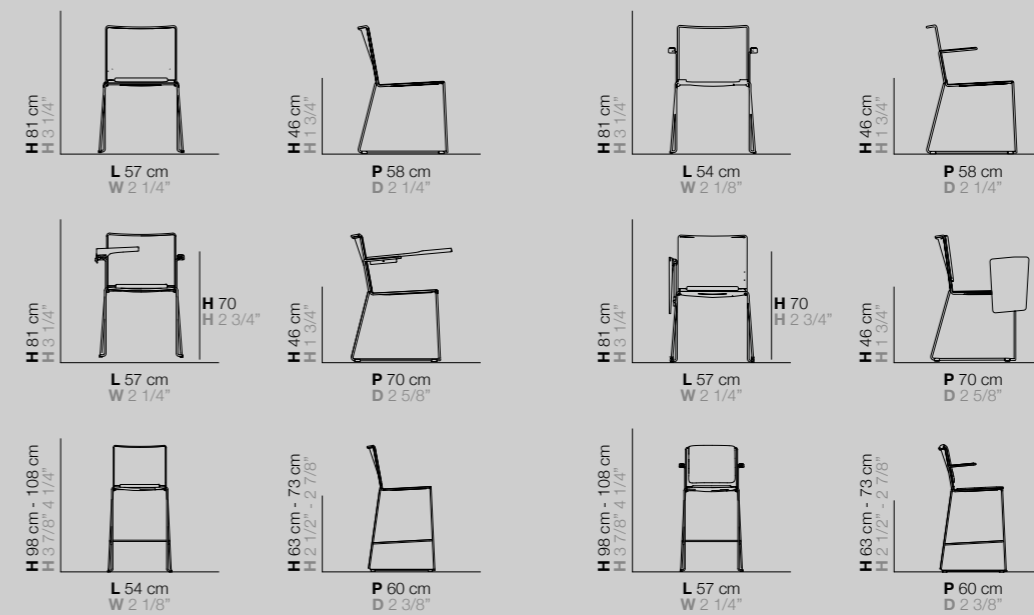

Carrello | Trolley | Chariot | Carrito

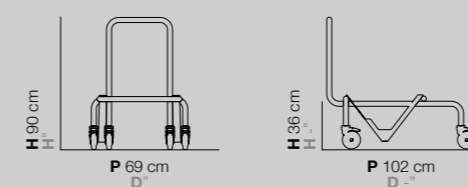

Carrello | Trolley | Chariot | Carrito

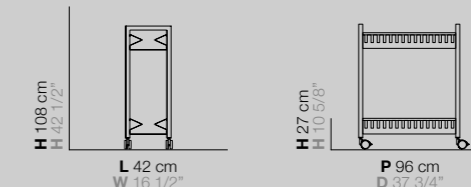

Finiture | Finishes | Finitions | Acabados

	STD STD STD		
Scocca Shell Coque Concha	→ /	Rivestimento sedile Seat upholstery Revêtement de siège Revestimiento del asiento	→
Struttura senza scrittoio Frame without writing table Structure sans tablette écrioire Estructura sin escritorio	→	Rivestimento schienale Backrest upholstery Revêtement du dossier Revestimiento del respaldo	→
Struttura con scrittoio Frame with writing table Structure avec tablette écrioire Estructura con escritorio	→ / /	Il rivestimento è obbligatorio sia sul sedile che nello schienale Upholstery is mandatory in both seat and back Le rembourrage est obligatoire pour le siège et le dossier El revestimiento es obligatorio tanto en el asiento como en el respaldo.	

Mix & match

Varianti Variants Variantes Variantes	Scocca Shell Coque Concha	Colori struttura senza tavoletta Frame colours without writing table Couleurs structure sans tablette écrioire Colores estructura sin escritorio	Struttura con tavoletta Frame colours with writing table Couleurs structure avec tablette écrioire Colores estructura con escritorio	Tessuti Fabrics Tissus Tejidos

materials and finishes

PPO POLIPROPILENE

Polypropylene | Polypropylène | Polipropileno

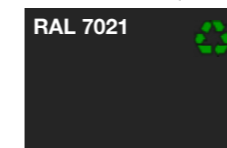

Carbone - Mod. C10
Charcoal
Charbon
Carbón

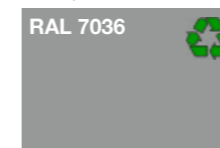

Roccia - Mod. C10
Rock
Roche
Roca

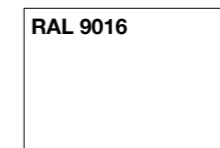

Neve - Mod. C10
Snow
Neige
Nieve

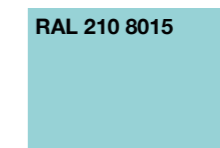

Cielo - Mod. C10
Sky
Ciel
Cielo

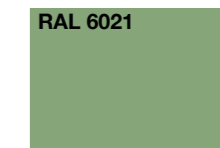

Tè verde - Mod. C10
Green tea
Thé vert
Té verde

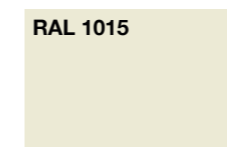

Crema - Mod. C10
Cream
Crème
Crema

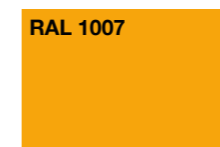

Zucca - Mod. C10
Pumpkin
Citrouille
Calabaza

PPO POLIPROPILENE

Polypropylene | Polypropylène | Polipropileno



Grafite - Mod. C20
Graphite
Graphite
Grafito

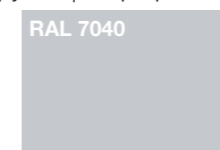

Cenere - Mod. C20
Ash
Cendre
Ceniza

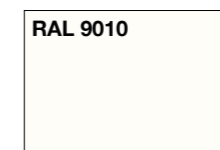

Ghiaccio - Mod. C20
Ice white
Glace
Hielo

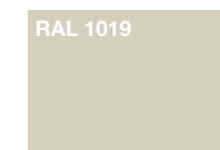

Nocciola - Mod. C20
Hazelnut
Noisette
Avellana

RET

RETE MEGA

Mega mesh | Résille Mega | Malla Mega



001 -
Mod. T10, T30, T50, M10

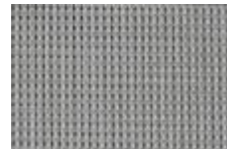

003 -
Mod. T10, T30, T50, M10

RETE PORTANTE

Supporting mesh | Résille de soutien | Malla reforzada

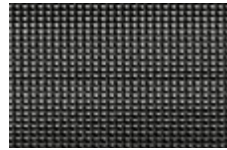

N00 - Mod. E10



N09 - Mod. E10



BL - Mod. T70, V20

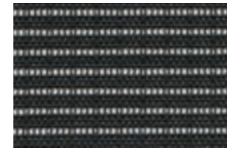

NK00 - Mod. H10



NK09 - Mod. H10

TES

BRAVO - Fidivi (CAT. S)

Tessuto | Fabric | Tissu | Tejido



8033



8009

SECRET - Flukso (CAT. A)

Similpelle | Faux leather | Faux-cuir | Semipiel

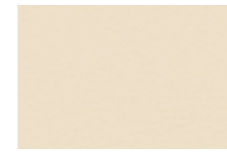

1003



1024



1006



1026



1019



1033



1012



1014



1017

ONE - Fidivi (CAT. A)

Tessuto | Fabric | Tissu | Tejido



8504



1506



4037



4503



3530

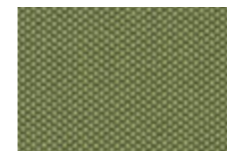

7521



7526



6555

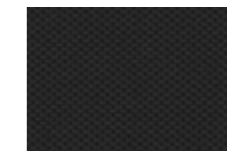

8033

CURA - Gabriel (CAT. A)

Tessuto | Fabric | Tissu | Tejido

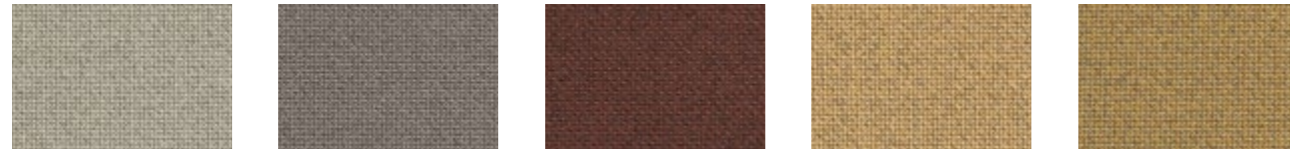

61168 60110 61258 61233 62083

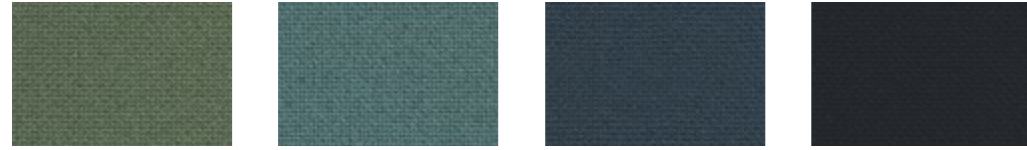

68182 66167 66170 60111

JET - Fidivi (CAT. A)

Tessuto | Fabric | Tissu | Tejido



9110 9804 9108 9402 9301



9305 9703 9702 7014 9608



9601 6098 9294 8033

GO UNI - Gabriel (CAT. B)

Tessuto | Fabric | Tissu | Tejido



66138 60093 60083 66139 61145



61144 67071 68149 60999

GO CHECK - Gabriel (CAT. B)

Tessuto | Fabric | Tissu | Tejido



60093 60083 60084 61145 61141



61139 68149 66139 66138

ACTON - Vescom (CAT. C)

Tessuto | Fabric | Tissu | Tejido



7062.20 7062.06 7062.05 7062.11 7062.29



7062.31 7062.32 7062.19 7062.18

PASSION - Gabriel (CAT. D)

Tessuto | Fabric | Tissu | Tejido



13101 1101 4101 16101 2101

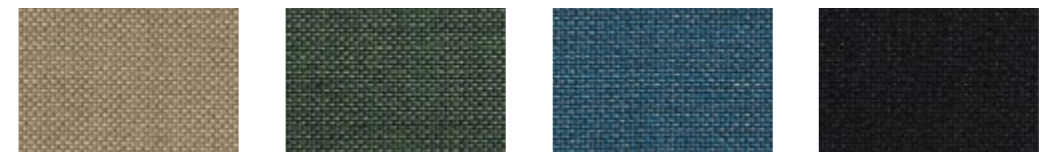

8101 24101 20101 12101

WOLIN - Vescom (CAT. D)

Tessuto | Fabric | Tissu | Tejido



7050.17



7050.03



7050.26



7050.47



7050.19



7050.37



7050.42



7050.09

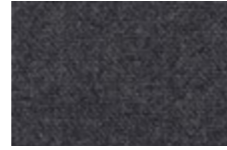

7050.10

CRISP - Gabriel (CAT. D)

Tessuto | Fabric | Tissu | Tejido



4032



4033



4021

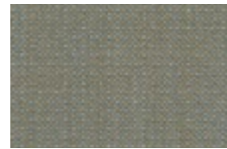

4603



4731



4721



4752



4013



4125

PEL

POLO - Anica (CAT. D)

Pelle | Leather | Cuir | Cuero



0947



0826



0822



0845



0838

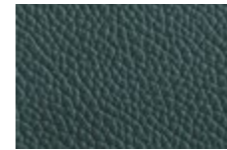

0832

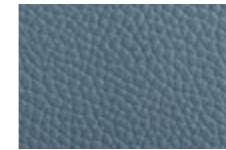

0878

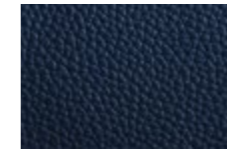

0856



0860

EPX

EPOSSIDICO Mod. E10

Epoxy | Époxy | Epoxi

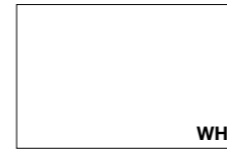

Bianco

White
Blanc
Blanco



Rosa sabbia

Sand rose
Rose sable
Rosa arena



Rosso vino

Wine red
Bordeaux
Vino tinto



Blu notte

Night blue
Bleu nuit
Azul medianoche



Antracite

Anthracite
Anthracite
Antracita



Verde intenso

Deep green
Vert foncé
Verde intenso



Nero

Black
Noir
Negro

Legenda simboli

Symbols key | Légende symboles | Leyenda signos

STD

Standard
Standard
Standard
Estandard



Su richiesta
On request
Sur demande
A petición



Impilabilità
Stackability
Empilabilité
Apilabilidad



Impilabilità su carrello porta sedie
Stackability on chair trolley
Empilabilité sur chariot porte-chaises
Apilabilidad en carrito de sillas



100% riciclato
100% recycled
100% recyclé
100% reciclado

POL

Polipropilene
Polypropylene
Polypropylène
Polipropileno

RET

Rete
Mesh
Réseille
Malla

TES

Tessuto
Fabric
Tissu
Tejido

PEL

Pelle
Leather
Cuir
Cuero

EPX

Epossidico
Epoxy
Époxy
Epoxi

Le finiture contenute nella stampa sono puramente indicative e non sono di riferimento per le forniture del prodotto
Due to the printing process, finishes shown in this document are for illustration only. The finish on the final item may differ slightly from the printed illustration
Les finitions contenues dans l'impression sont purement indicatives et ne sont pas pertinentes pour les fournitures du produit
Los acabados contenidos en la impresión son puramente indicativos y no son de referencia para los suministros del producto

Visual & graphic design

Alea marketing + communication

AL/CACD/CG

alea
aleaoffice.com



GLOBAL HEADQUARTERS AND SHOWROOM : Via Col de Rust, 19 - 33070 Sarone (PN) -
Italia : Tel ++39 0434 777 333 email: info@aleaoffice.com **MILANO SHOWROOM** : Via Cino del Duca, 2 - 20122
PARIS SHOWROOM : 176 Avenue Charles de Gaulle 92200, Neuilly-sur-Seine - France **NORTH AMERICAN HEADQUARTERS** :
Midtown 2, 3449 NE 1st Avenue L-32, Miami, FL 33137 - USA : Tel ++1 305 470 1200 - email: info@alea-usa.com
ALEA UK OFFICE AND SHOWROOM : 50-54 Clerkenwell Road, London EC1M 5PS - email: info@aleaoffice.com